

Notes on Designing Large 5-Band Quads

L. B. Cebik, W4RNL

The design of large 5-band quad arrays has a number of facets, each of which deserves attention by the would-be quad user. We can divide them into three general groups.

1. The use of antenna modeling software as the design vehicle: how do we set up the model for effective design work?
2. The performance of the quad as designed: how can we use the modeled performance as a guide to evaluating and improving designs?
3. The transition from model to physical antenna: what factors play a role in determining if and how the modeled array should be built?

Although it is not possible to provide definitive answers to all of these questions, we can run through a design exercise and extract as much guidance from it as possible. Although not exhaustive, the amount of guidance will be considerable.

For our project, let's consider the design of one or more large 5-band HF quad arrays. By large, I mean an array with at least 4 elements per band.

Setting Up the Design Project

The availability of NEC-based antenna modeling programs has moved much of the design process from the antenna tower to the computer. However, the process of design may prove daunting unless we approach it in a somewhat systematic manner.

Constraints: Designing a large quad array involves some concessions to reality from the start. For example, multi-band quad arrays typically employ planar groups of elements, that is, flat, 4-arm non-conductive structures to support an element for each of the bands of concern. Consequently, the designer cannot for each band select the optimal spacing between elements for maximizing key performance parameters, such as gain, front-to-back ratio, and SWR bandwidth. Every performance outcome will be a compromise whose foundation lies in the initial spacing decisions for the sets of support arms.

Equally limiting will be the fact that quad arrays typically use wire elements. At the outset, I shall specify #12 AWG copper wire as the material of choice for this exercise. However, that very choice will limit and direct the design effort. As I have elsewhere shown, the gain and the operating bandwidth (in terms of both the front-to-back ratio and the 2:1 SWR curves) are functions of the element diameter when specified as a fraction of a wavelength.¹ In the upper HF region, #12 wire is a small fraction of a wavelength. Achieving full operating potential requires element diameters approaching about 0.5" at 10 meters and 1" at 20 meters.

However, the planar arrangement of elements does permit the quad designer to achieve--at least on some bands--a higher level of performance than would be provided by a monoband version of the array using similar dimensions.² The effects of element interactions on the large quad array will be among the phenomena that we shall examine in the course of the work.

A Starting Point: Because so many examples of large quad array design already exist, we need not begin at random. One of the better designs available is the product of Danny Mees, ON7NQ.³ It consists of 3 elements on 20, 17, and 15 meters, with a fourth element added for 12 and 10 meters. As a 3-element quad on the lower three bands, the array uses one of the standard set of element spacings. As shown in part of **Fig. 1**, the reflector is 10' from the driver, with a director 8' forward of the driver. On 12 and 10 meters, Danny added new elements 5' each from the reflector and the driver. The new element became the driver for the upper two bands, with two directors to the front of it. **Table 1** supplies the modeled dimensions of the ON7NQ 3-4-element quad. The table also contains the dimensions of the larger quads that we shall explore, so we shall return to it from time to time. **Fig. 2** shows the general outline of the entire ON7NQ array.

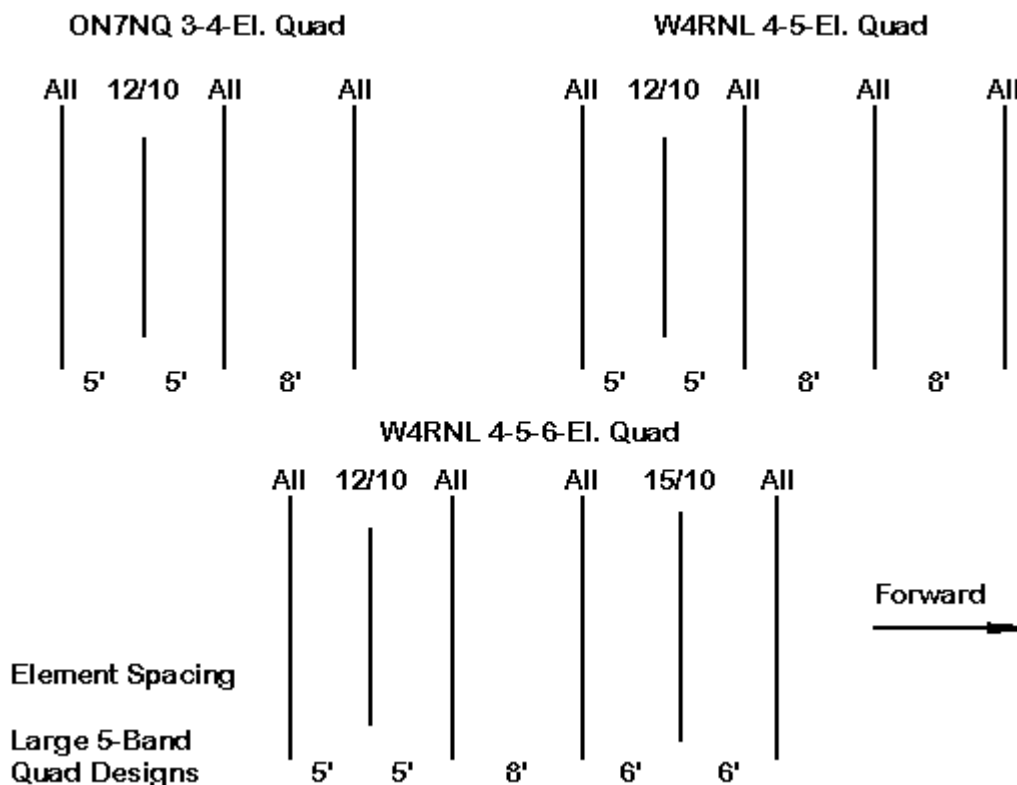

Fig. 1. Element spacing for 3 large 5-band quad designs

3-Large 5-Band Quad Array Dimensions

ON7NQ 3-4-Element 5-Band Quad Dimensions (Inches)

Antenna Part	Side Length	Loop Circumference
20 Refl	217.0	868.0
20 Dri	213.7	854.8
20 Dir 1	205.0	820.0
17 Refl	168.5	674.0
17 Dri	166.3	665.2

17 Dir 1	159.8	639.2
15 Refl	144.8	579.2
15 Dri	142.0	568.0
15 Dir 1	138.0	552.0
12 Refl	122.4	489.6
12 Dri	119.9	479.6
12 Dir 1	118.2	472.8
12 Dir 2	118.7	474.8
10 Refl	110.68	442.7
10 Dri	105.8	423.2
10 Dir 1	104.6	418.4
10 Dir 2	103.99	416.0

W4RNL 4-5-Element 5-Band Quad Dimensions (Inches)

Antenna Part	Side Length	Loop Circumference
20 Refl	217.0	868.0
20 Dri	213.0	852.0
20 Dir 1	195.0	780.0
20 Dir 2	196.0	784.0
17 Refl	168.5	674.0
17 Dri	165.6	662.4
17 Dir 1	159.8	639.2
17 Dir 2	159.8	639.2
15 Refl	145.4	581.6
15 Dri	141.4	565.6
15 Dir 1	139.5	558.0
15 Dir 2	139.3	557.2
12 Refl	122.4	489.6
12 Dri	120.6	482.4
12 Dir 1	118.2	472.8
12 Dir 2	119.8	479.2
12 Dir 3	118.6	474.4
10 Refl	110.0	440.0
10 Dri	105.8	423.2
10 Dir 1	104.4	417.6
10 Dir 2	105.0	420.0
10 Dir 3	104.0	416.0

W4RNL 4-5-6-Element 5-Band Quad Dimensions (Inches)

Antenna Part	Side Length	Loop Circumference
20 Refl	217.0	868.0
20 Dri	213.0	852.0
20 Dir 1	201.2	804.8
20 Dir 2	194.8	779.2
17 Refl	168.5	674.0
17 Dri	165.6	662.4

17 Dir 1	160.2	640.8
17 Dir 2	159.6	638.4
15 Refl	145.8	583.2
15 Dri	141.4	565.6
15 Dir 1	139.0	556.0
15 Dir 2	138.8	555.2
15 Dir 3	138.4	553.6
12 Refl	121.8	487.2
12 Dri	120.2	480.8
12 Dir 1	119.4	477.6
12 Dir 2	120.2	480.8
12 Dir 3	117.4	469.6
10 Refl	110.6	442.4
10 Dri	105.7	422.8
10 Dir 1	104.4	417.6
10 Dir 2	104.8	419.2
10 Dir 3	104.8	419.2
10 Dir 4	104.2	416.8

Table 1. Dimensions in inches of 3 large 5-band quad arrays. See text and Fig. 1 for element spacing data.

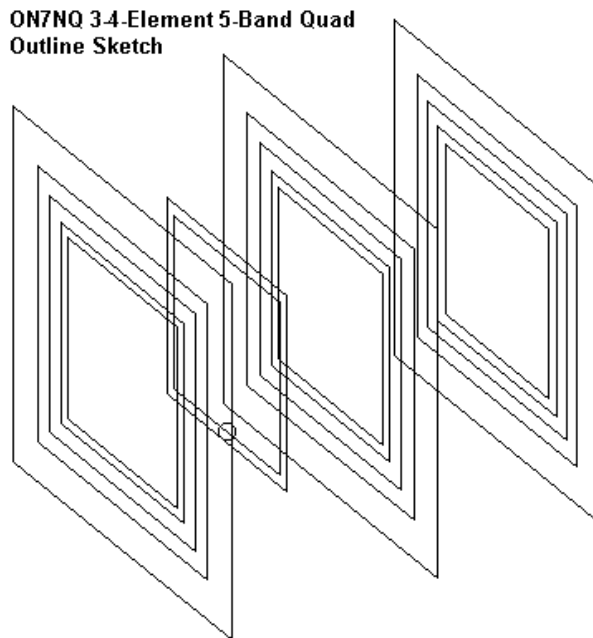

Fig. 2. Outline sketch of the 3-4-element ON7NQ 5-band quad

Since one facet of quad design is reducing the number of variables with which we must deal, it may prove useful to accept the initial spacing selections of the ON7NQ array as a starting point. Then we shall add one or more elements to each band. **Fig. 1** shows the spacing for the first of the two resulting arrays. An additional director has been added, once more at the somewhat standard 8' spacing from the ON7NQ forward element, resulting in a 26' boom. Thus, we have a 4-5-element array. **Fig. 3** shows an outline sketch of the full set of elements.

**W4RNL 4-5-Element 5-Band Quad
Outline Sketch**

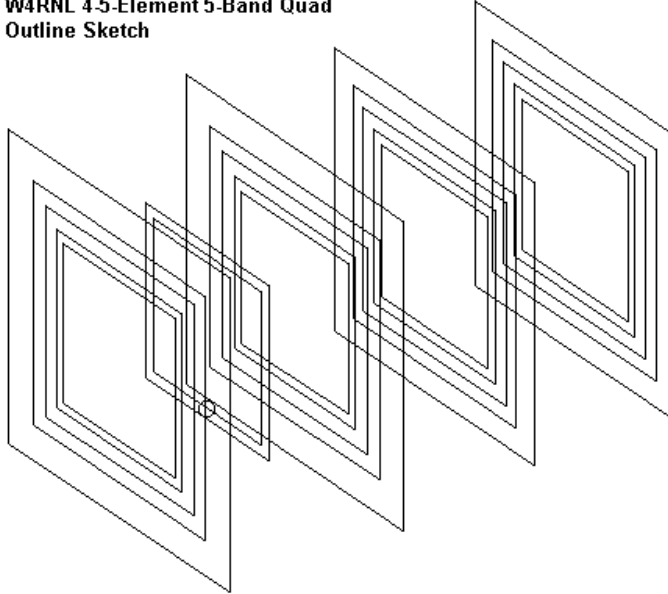

Fig. 3. Outline sketch of the 4-5-element W4RNL 5-band quad.

When the model reports suggested that we might achieve additional performance benefits from using a wider spacing for the new director, the third spacing sketch in **Fig. 1** came into play. It places the forward elements 12' from the ON7NQ forward elements for a 30' boom length. However, for reasons that will become clear as we proceed to analyze the design, it became necessary to add another partial element set equi-spaced between the two most forward full element sets. The new support holds elements only for 15 and 10 meters. The end product is a 4-5-6-element quad array, an outline sketch of which appears in **Fig. 4**.

**W4RNL 4-5-6-Element 5-Band Quad
Outline Sketch**

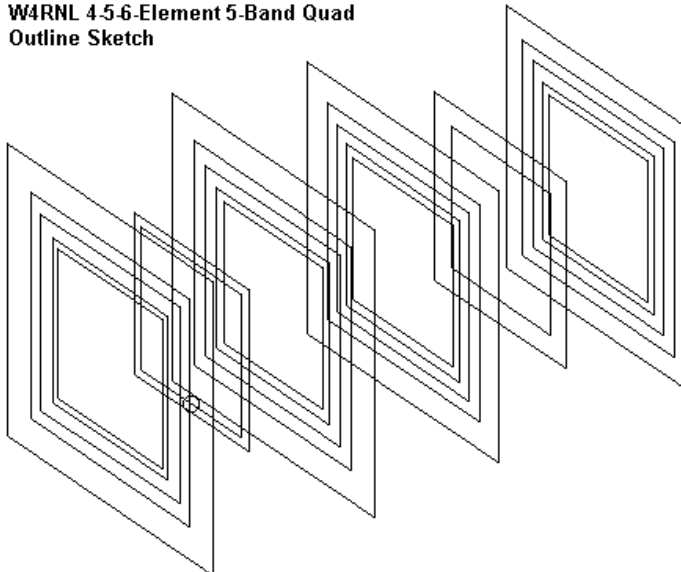

Fig. 4. Outline sketch of the 4-5-6-element W4RNL 5-band quad.

Specifications: The design process might proceed without a set of goals, but then, one would never know when to stop. A set of clear specifications, based on reasonable expectations that emerge from experience, can direct the work of optimizing a design, converting an endless task into a merely long but finite one. For the design project at hand, the following specifications were set for the 4-5-element quad.

Gain: The average free-space gain of the 4-5-element quad should be about 0.7 dB higher than the ON7NQ array on each band. This goal is likely to be achieved on all but 20 meters, where the boom length is short for 4 elements. The length is adequate for a monoband optimized Yagi, but the fixed spacing of the quad array limits improvements. First, a monoband quad generally requires greater spacing than a monoband Yagi to achieve its full gain potential for any element diameter. Second, on 20 meters, the elements do not have other elements outward from which to potentially derive a modicum of performance enhancement. Third, the individual element spacing may not be optimal.

When the spacing was increased to the 30' boom length for the 4-5-6-element array, the gain specification was raised by about 0.2 dB as the design goal.

Front-to-Back Ratio: It is almost impossible to obtain a 20-dB front-to-back ratio from a wire quad on any HF band (except for the non-harmonic or WARC bands). Consequently, that standard, long applied to monoband Yagi designs, had to be set aside. More realistic is the goal of achieving a 15 dB front-to-back ratio across the bands. Even this reduced standard cannot be achieved on every band with every configuration. Part of the analysis will deal in why some bands with some array configurations fall short of the goal.

The front-to-back specification is given in terms of the 180° front-to-back ratio. Due to element interactions and the fixed spacing of the elements, a full front-to-rear evaluation will only sometimes match the 180° front-to-back ratio. A front-to-rear evaluation examines the entirety of the radiation pattern to the rear of the beam. Large multi-band quad array rear patterns can range from good to exceptionally "messy."

Feedpoint Impedance: Since the ON7NQ array was designed for direct feed with a 50-Ω coaxial cable, the larger arrays also used this feedpoint impedance as a specification. The usual 2:1 SWR standard will be applied to determine if the feedpoint impedance falls within the range limits.

Bandwidth Coverage: Although the ON7NQ array was optimized for the CW end of each of the HF bands covered, the goal for the larger arrays was to allow operation on all of the band. In the performance analysis, we shall find limitations to this goal. 20 meters is especially resistant to full coverage within the other performance specifications. As well, 10 meters was limited to coverage of the first 800 kHz (from 28.0 to 28.8 MHz), since broader coverage required a severe reduction of performance levels. This decision was made in the process of design, as we shall later see.

Strategy: The discussion of a starting point and a set of specifications involve basic "whats" but do not tell us anything of the "how" of design. Design work with antenna modeling software requires something of a strategy if the work is to proceed effectively, if not efficiently. Modeling a 5-band quad of more than 3 elements/band results in a large model for most amateurs.

Moreover, each element that will be modified in the design process involves--assuming a free-space model--the alteration of 16 coordinate values for each and every change. For the task at hand, modeling software that permits the use of variables as coordinates can simplify the work of alteration to a single operation. Consequently, the design work was performed on NEC-Win Plus, which permits 24 variable assignments--just enough for the entire project without resorting to work-arounds.

Full Segmentation Scheme: 7 to 15 Segments per Wire

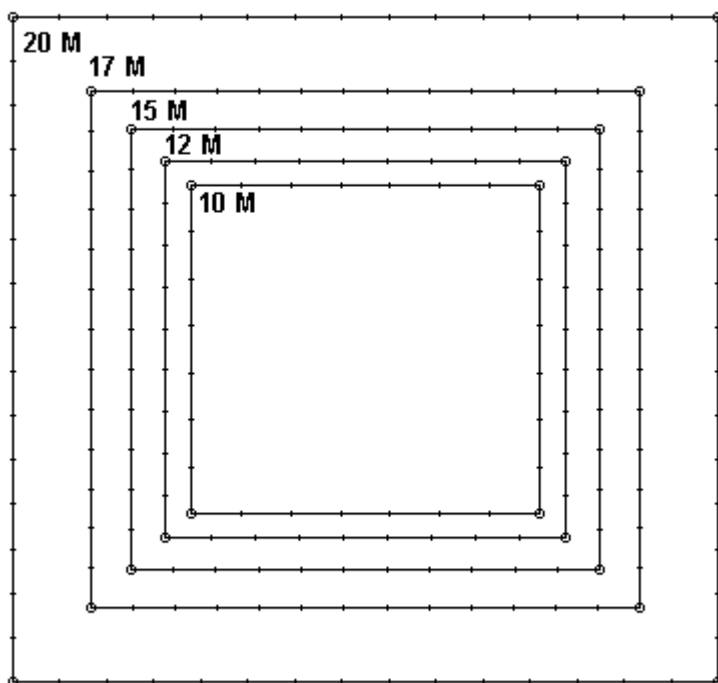

Fig. 5. Recommended "full" segmentation of a 5-band set of quad elements.

Another strategic issue is the segmentation of the element loops. Ideally, a good NEC model attempts to align segment junctions to achieve maximum accuracy. As well, since all wires are to some degree active on all bands, the 20-meter elements should have about twice the number of segments as the 10-meter elements so that each segment is about the same length at the highest frequency to be used. Since 5 segments per side is about the minimum level of segmentation to assure accurate results with a closed loop structure, the overall segmentation becomes a matter of number juggling. If we place 7 segments on each side of a 10-meter element and if we increase the number by 2 for each lower band in order, we arrive at 15 segments per side on the 20-meter elements. **Fig. 5** sketches the elements and the suggested level of segmentation for 1 set of elements for 5 bands. This segmentation scheme comes close to meeting the desired 2:1 ratio of segments between 20 and 10 meters and yields as close an alignment of segment junctions from one band to the next as is practical to achieve.

The resulting arrays are large in both the number of wires and the number of segments. A fully segmented ON7NQ array requires 68 wires and 724 segments, already more sizable than

the limits of some widely used software. The 4-5-element array needs 88 wires and 944 segments, while the final 4-5-6-element quad calls for 96 wires and 1016 segments. Since the time required for each run of the modeling core goes up by powers of both the number of wires and the number of segments, core runs for the largest array approached the duration within which the designer might easily lose interest in the project.

The solution is to use a lower level of segmentation, but only after verifying its adequacy, if not its accuracy. Therefore, I ran a set of comparative curves on the ON7NQ array using full segmentation and a lower level: 5-segments per side for the upper 3 bands and 7 segments per side for the lowest 2 bands. The resulting models produced operating bandwidth performance data such that in only two instances was a final small adjustment required using the fully segmented model. However, the actual gain and front-to-back figures were sufficiently off that only the performance curves were used to optimize the model. The performance tables to follow reflect the number yielded by the fully segmented models.

Table 1 provides the dimensions that emerged for the larger arrays. Without adequate preparation as outlined above, the few hours of work needed to produce these figures might well have been lengthened into the work of many weeks.

Design Evaluation

In the course of the design exercise, a number of interesting properties of large quad arrays emerged. Some of the patterns that make up the properties might not have been so easily discovered without the efficiency of computer-aided design, although automated design might also have obscured some of them. Let's analyze the designs, band by band, to see what we might uncover. We shall use a mixture of tabular and graphic data to examine each band, with performance curves being most applicable to the wider HF bands.

20-Meter Performance

Freq. MHz	Gain dBi	Front/Back dB	Impedance R +/- jX	50-Ohm SWR
ON7NQ 3-4-Element, 5-Band Quad				
14.0	8.42	11.83	37.6 - j 18.5	1.66
14.175	8.29	15.06	44.3 + j 4.4	1.17
14.35	8.06	9.76	34.8 + j 36.5	2.50
W4RNL 4-5-element, 5-Band Quad				
14.0	8.81	15.02	33.6 - j 20.5	1.88
14.175	8.58	16.76	51.9 + j 10.0	1.22
14.35	8.14	9.96	57.8 + j 33.8	1.89
Average gain over 3-4: 0.25 dB				
W4RNL 4-5-6-element, 5-Band Quad				
14.0	9.04	15.37	31.7 - j 18.4	1.89
14.175	8.82	17.82	54.9 + j 12.8	1.29
14.35	8.41	10.36	56.6 + j 35.3	1.94
Average gain over 4-5: 0.25 dB			Average gain over 3-4: 0.50 dB	

Table 2. 20-Meter performance of 3 quad arrays.

20 Meters: With respect to gain, all of the large arrays show a steady increase with each step upward in frequency band. Of all the bands, 20 meters shows the least improvement as we enlarge the array. **Table 2** provides the data at check points for the band edges and the middle of the band. **Fig. 6** sweeps the band to provide a fuller picture of the free-space gain.

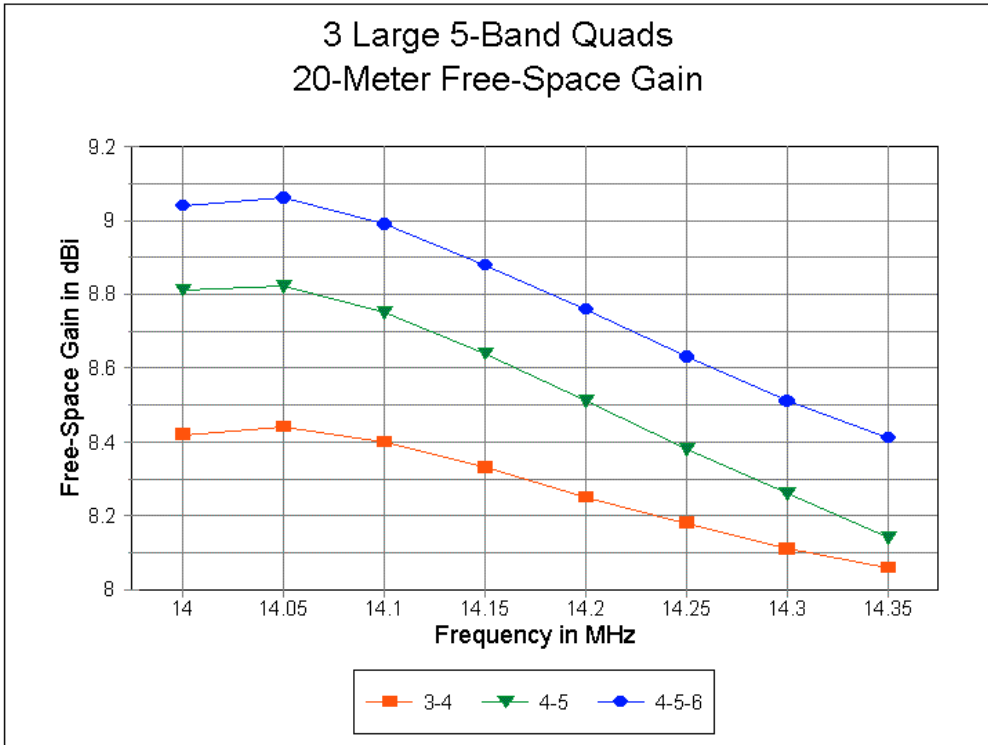

Fig. 6. 20-meter free-space gain for 3 large 5-band quad designs.

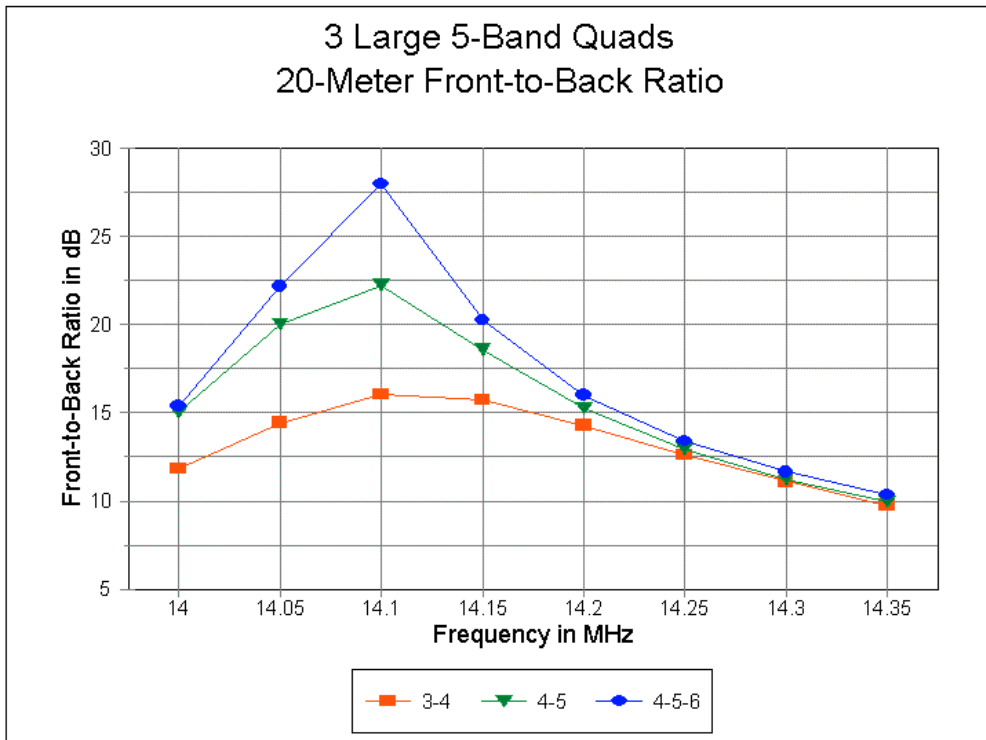

Fig. 7. 20-meter front-to-back ratios for 3 large 5-band quad designs.

At the low end of the band, the 4-5 array shows a significant increase over the 3-4 version. The gain increase tapers off as we move up the band so that the average gain margin between versions 3-4 and 4-5 is the same as between version 4-5 and 4-5-6. However, the gain of version 3-4 had been optimized at the expense of full-band coverage. Both 4-5 and 4-5-6 provide full coverage of 20 meters, even if at lesser levels at the high end of the band.

The front-to-back ratio curves for all three quad versions appear in **Fig. 7**. The curves are roughly congruent, but the increasing boom length of the array as we move from one version to the next yields a higher peak value at about 14.1 MHz. Although both larger arrays have a higher ratio than the original array at the low end of the band, all three pass the upper end of the band with similar values. Likewise, as shown in **Fig. 8**, the 2 larger arrays have similar SWR curves that barely fit within the band at less than 2:1 SWR relative to 50 Ω . In this feature, they are superior to the original ON7NQ array, since its SWR curve cannot be moved sufficiently to cover the entire band without a significant reduction in peak gain.

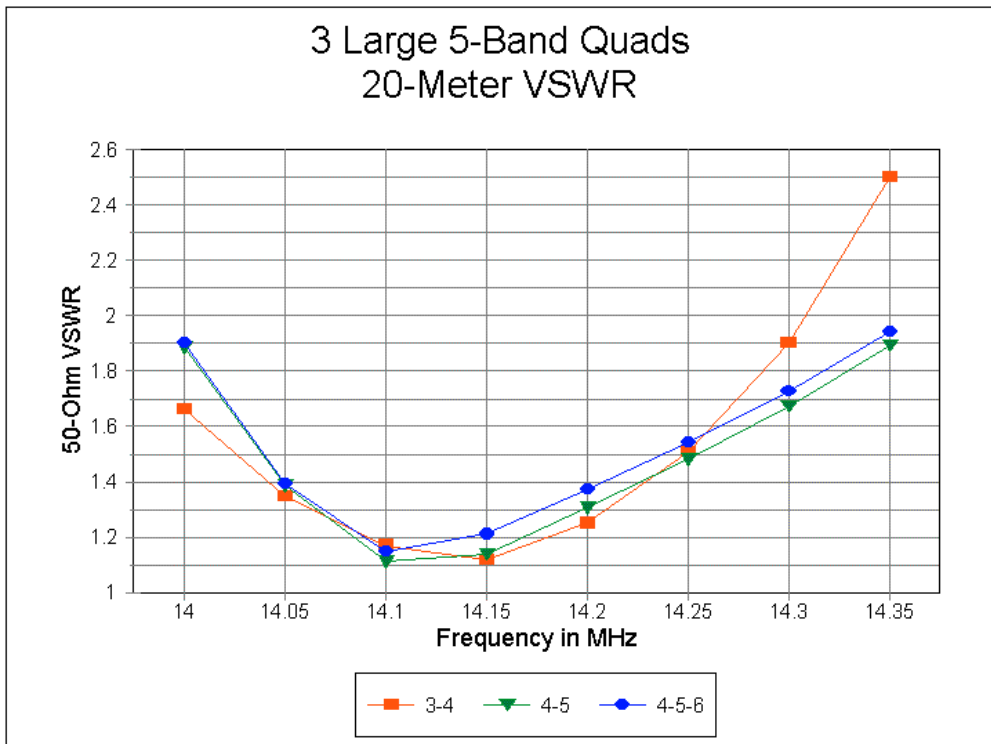

Fig. 8. 20-meter 50- Ω SWR curves for 3 large 5-band quad designs.

Adding a second director to the initial ON7NQ starting point thus allows an improvement of gain of modest amounts, with the longer-boom model showing additional gain. The added director permits coverage of the entire 20-meter band by judicious selection of director loop sizes, which differ as we change the boom length. Without major changes in individual element spacing, further significant performance improvement is unlikely, since the first director has two functions. In combination with the driver and the reflector, it sets the feedpoint impedance. In combination with the second director, it sets the operating bandwidth for the major parameters. Hence, the 2 4-element 20-meter sections use very different director sizes, although the driver and reflector remain constant. All in all, both larger 20-meter sections have boom lengths that remain well under 0.4 λ , which is short for 4-element parasitic arrays.

17 Meters: Because 17 meters is such a narrow band (100 kHz), the data in **Table 3** will suffice to permit an evaluation of the performance of the arrays on this band. Three factors allow the 17-meter portions of the larger arrays to achieve significant gain over the initial 3-element quad. First, the boom length increases as a fraction of a wavelength so that the two new designs bracket a half wavelength of boom length. Second, the extra element is well suited to setting the element mutual coupling for a higher gain level. Third, the 17-meter band is narrow, permitting the operating performance to be well focused.

17-Meter Performance

Freq. MHz	Gain dBi	Front/Back dB	Impedance R +/- jX	50-Ohm SWR
ON7NQ 3-4-Element, 5-Band Quad				
18.068	8.47	21.80	42.7 - j 5.1	1.21
18.118	8.42	25.52	43.5 - j 0.3	1.15
18.168	8.36	20.90	43.2 + j 4.6	1.19
W4RNL 4-5-element, 5-Band Quad				
18.068	9.24	22.03	36.0 - j 1.7	1.39
18.118	9.18	21.26	39.3 + j 5.7	1.31
18.168	9.10	17.39	42.3 + j 12.5	1.37
Average gain over 3-4: 0.75 dB				
W4RNL 4-5-6-element, 5-Band Quad				
18.068	9.45	18.43	42.7 + j 0.7	1.17
18.118	9.39	21.33	47.9 + j 6.5	1.15
18.168	9.31	20.50	42.4 + j 10.8	1.24
Average gain over 4-5: 0.21 dB			Average gain over 3-4: 0.96 dB	

Table 3. 17-Meter performance of 3 quad arrays.

Nevertheless, the 30' boom version requires different lengths than the 26' version for the 2 directors in order to achieve the final 0.2-dB gain increment. However, the added length also permits the designer to obtain feedpoint impedances closer to 50 Ω, even though both 4-element sections have comparable front-to-back ratio values.

Despite the factors that allow the 17-meter section to achieve gain in excess of the specifications for the larger arrays, the gain differential between the 17-meter and 20-meter sections calls for brief comment. The longer boom length in terms of a fraction of a wavelength and the narrow band requirements on 17 meters contribute to the gain excess over 20 meters. However, the 17-meter elements in their planar supports are surrounded on both sides by elements for other bands. Changes in the 20-meter and 15-meter elements do affect the performance curves of 17 meters--much more of an effect than changes to the 17-meters elements have upon the 20-meter performance curves. In general, being surround by elements for other bands tends (but not without exceptions) to improve gain but also to slightly reduce the front-to-back ratio and SWR bandwidth.

15 Meters: As shown in **Table 4** and in **Fig. 9**, 15 meters is marked by remarkable gain

stability in all 3 versions of the arrays. The gain improvement on the 4-5 array over the 3-4 array is in excess of 1 dB, with another 1/3 dB added by the increased boom length of the 4-5-6 quad. However, the values, which are in excess of expectations for the 4-5-6-element design, required the addition of a new director 6' between the first and second directors for 20 and 17 meters. **Table 4** provides the best gain values obtain with the longer boom, but without the added director. Obviously, the longer boom--about 5/8 λ --was insufficient to provide stable gain across the band without an intervening director.

15-Meter Performance

Freq. MHz	Gain dBi	Front/Back dB	Impedance R +/- jX	50-Ohm SWR
ON7NQ 3-4-Element, 5-Band Quad				
21.0	8.43	15.28	49.7 - j 20.1	1.49
21.225	8.52	20.98	46.4 - j 0.0	1.08
21.45	8.47	10.24	36.2 + j 30.7	2.16
W4RNL 4-5-element, 5-Band Quad				
21.0	9.49	15.33	41.4 - j 15.6	1.47
21.225	9.47	17.04	57.0 + j 7.5	1.21
21.45	9.55	19.16	31.3 + j 9.9	1.70
Average gain over 3-4: 1.03 dB				
W4RNL 4-5-6-element, 5-Band Quad (before adding 5th element)				
21.0	9.36	11.43	46.4 - j 19.8	1.51
21.225	9.65	22.65	58.1 - j 8.8	1.25
21.45	9.95	15.68	28.2 + j 8.7	1.85
W4RNL 4-5-6-element, 5-Band Quad (after adding 5th element)				
21.0	9.78	15.70	46.9 - j 7.6	1.19
21.225	9.74	20.57	63.4 + j 1.0	1.27
21.45	10.00	15.03	35.0 + j 11.9	1.57
Average gain over 4-5: 0.34 dB			Average gain over 3-4: 1.37 dB	

Table 4. 15-Meter performance of 3 quad arrays.

The front-to-back curves for 15 meters, shown in **Fig. 10**, are equally interesting. The initial 3-4 array, with a single director for 15 meters, shows the typical "spike" in the front-to-back value. However, both longer-boom models provide much smoother performance across the entire band. The smoother performance is also reflected in the feedpoint impedance values in the tables. The 3-4 array can be adjusted for less than 2:1 SWR across the band, but it cannot approach the leveled values for the longer boom arrays.

Part of the reason for the impedance and SWR situation is revealed in **Fig. 11**, the 50- Ω SWR curves for the three arrays. The 3-4 array shows the typical curve of a 3-element beam, with a single point at which SWR is minimum. Both the 4-5 and the 4-5-6 element arrays display two SWR minimums at distant points within the band. The double-dip curve is a mark of "wide-band" tuning of a parasitic array, as the term is defined in the series of Yagis designed by NW3Z

and WA3FET.⁴

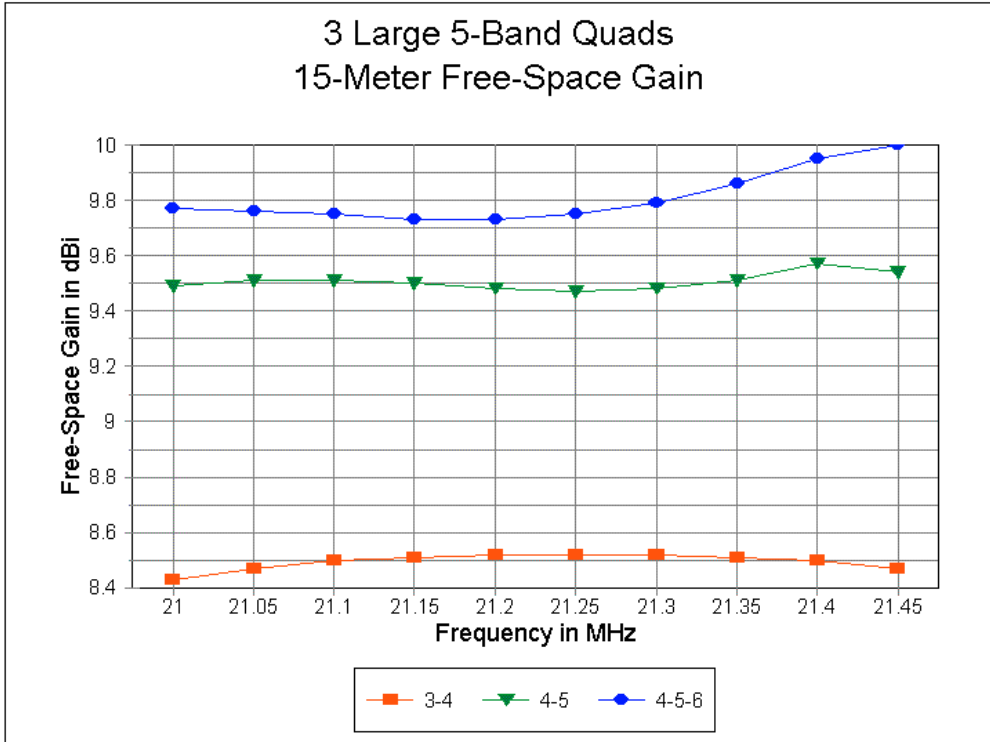

Fig. 9. 15-meter free-space gain for 3 large 5-band quad designs.

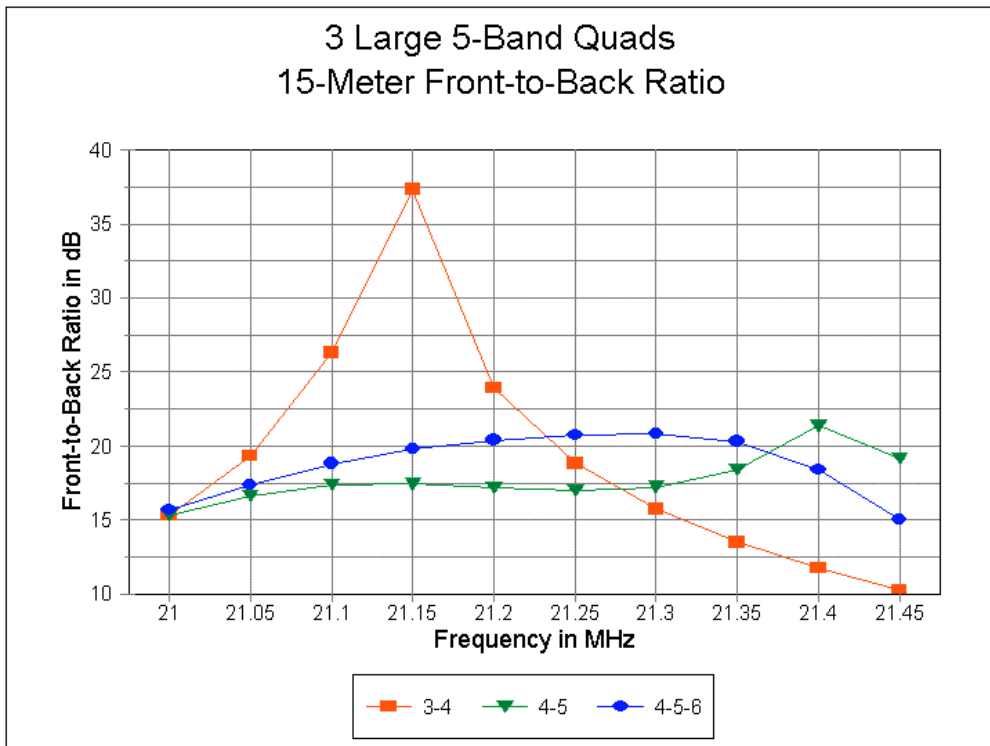

Fig. 10. 15-meter front-to-back ratios for 3 large 5-band quad designs.

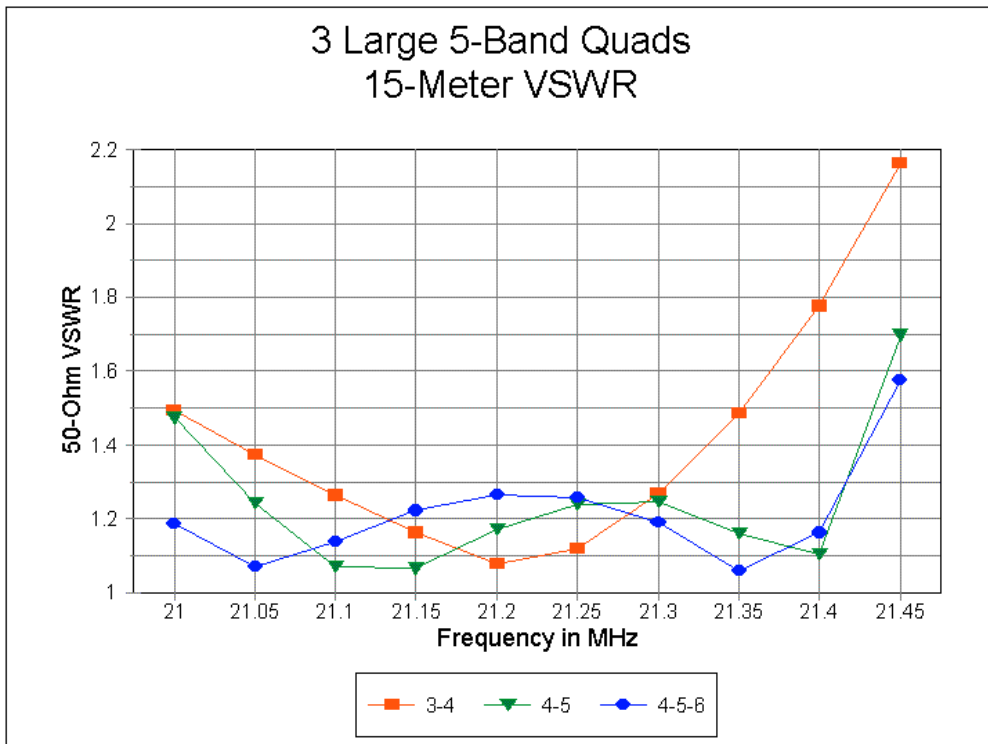

Fig. 11. 15-meter 50-Ω SWR curves for 3 large 5-band quad designs.

The 15-meter array spaces the reflector and the first director at nearly optimal distances from the driver to set the feedpoint impedance for wide-band 50-Ω operation. The reflector is about 0.216λ behind the driver, while the first director is about 0.173λ ahead. Gain is then provided by the additional director or directors, as reflected in the dimensions for those elements in **Table 1**. The additional director in the 30' model permits the designer to achieve smoother wide-band performance in all categories at a boom length that is beyond the capabilities of a single director. Both larger quads call for a smooth decrease in the sizes of the directors, although some wide-band applications with 5 elements may require that the second director be equal to or slightly larger than the first director. This phenomenon is an indicator that the forward 2 directors are used as the principal determinants of the bandwidth for the gain and front-to-back curves.

12 Meters: For all three arrays, 12 meters is the lowest band to use a driver spaced 5' from the reflector, with the element at the 10' mark becoming a director. **Table 5** provides the operating figures for this 5-element section. The 4-5 (26') array provides over 1 dB gain improvement over the 3-4 (18') array on 12, with similar front-to-back and SWR curves.

When increasing the boom length to 30', the forward director moves from 0.2 to 0.3λ ahead of the second director. The larger spacing is near the limit of the ability of the forward two directors to control both gain and front-to-back ratio, even on a narrow band such as 12 meters (100 kHz). Indeed, without a further director, one can improve either the gain or the smoothness of the front-to-back ratio--but not both. As shown in **Table 5**, the design approach used for the 4-5-6 array was to raise the lowest level of front-to-back ratio by about 2 dB--a value that just verges on operational detectability.

12-Meter Performance

Freq. MHz	Gain dBi	Front/Back dB	Impedance R +/- jX	50-Ohm SWR
ON7NQ 3-4-Element, 5-Band Quad				
24.89	9.26	22.72	35.1 - j 2.1	1.43
24.94	9.22	18.92	41.1 + j 2.3	1.27
24.99	9.18	16.70	47.6 + j 4.8	1.12
W4RNL 4-5-element, 5-Band Quad				
24.89	10.27	21.77	38.6 + j 5.2	1.33
24.94	10.29	19.80	40.2 + j 9.1	1.34
24.99	10.25	16.77	41.9 + j 14.3	1.43
Average gain over 3-4: 1.04 dB				
W4RNL 4-5-6-element, 5-Band Quad				
24.89	10.34	18.78	25.9 + j 3.5	1.94
24.94	10.37	20.98	37.0 + j 7.9	1.42
24.99	10.25	21.69	49.1 - j 2.5	1.06
Average gain over 4-5: 0.06 dB			Average gain over 3-4: 1.10 dB	

Table 5. 12-Meter performance of 3 quad arrays.

As a result of this design decision, the gain of the longer-boom array increases insignificantly over that of the 26' model. However, since the overall gain increase, relative to the initial 3-4-element array, was well in excess of 1 dB, the decision seems appropriate. For the same reason, a new director was not added to the support arms used for the added 15-meter director. The absence of an added director for 12 meters illustrates once more the different requirements for the narrow and wide amateur HF bands.

10 Meters: Of all the HF bands, 10 meters is the widest. From the outset, it was apparent that a thin-wire quad array could not be pressed at any reasonable gain level to cover even the full first MHz of 10. An 800 kHz operating bandwidth is much more feasible goal, and it is achieved by all three arrays, as shown in **Table 6**.

On average, the 4-5-element quad shows better than 0.8 dB more gain than the 3-4 array. The 30' boom model adds more than 0.4 dB more gain (using a fourth director), for a 1.25 dB total improvement over the original 18' quad design. However, these figures--as averages--may be deceptively simple in view of the wide operating bandwidth on 10 meters.

Despite the best efforts to achieve a smooth gain performance, 10 meters exhibits the highest differential between minimum and maximum gain for all three of the arrays. The differential runs between 0.9 dB and 1.1 dB, depending on the version of the array. The 4-5-6-element array would have shown an unacceptably high differential--more than 1.5 dB--had the final design not included a new director on the same support arms as the added 15-meter director. **Fig. 12** show the gain curves for all three final designs. Even with the new director, the 4-5-6 version displays a more rapid gain fall-off at the upper end of the band than the other two quads.

10-Meter Performance

Freq. MHz	Gain dBi	Front/Back dB	Impedance R +/- jX	50-Ohm SWR
ON7NQ 3-4-Element, 5-Band Quad				
28.0	9.01	18.40	43.8 - j 31.6	1.96
28.2	9.35	25.89	45.3 - j 11.0	1.29
28.4	9.62	30.72	51.3 + j 6.8	1.15
28.6	9.85	22.80	58.7 + j 9.6	1.27
28.8	9.73	12.38	31.1 + j 8.1	1.68
W4RNL 4-5-element, 5-Band Quad				
28.0	9.59	12.15	40.7 - j 27.4	1.88
28.2	10.15	17.00	49.3 - j 12.7	1.29
28.4	10.60	20.50	47.1 - j 2.8	1.09
28.6	10.85	19.76	42.6 + j 18.0	1.52
28.8	10.51	29.74	64.9 + j 12.1	1.40
Average gain over 3-4: 0.83 dB				
W4RNL 4-5-6-element, 5-Band Quad (before adding 6th element)				
28.0	9.54	18.64	41.3 - j 19.4	1.59
28.2	10.22	43.18	40.0 - j 1.3	1.25
28.4	10.72	20.43	39.2 + j 23.6	1.78
28.6	11.04	16.89	59.1 + j 55.3	2.70
28.8	10.67	11.37	56.4 - j 19.1	1.46
W4RNL 4-5-6-element, 5-Band Quad (after adding 6th element)				
28.0	10.21	13.85	58.9 - j 31.2	1.80
28.2	10.80	20.75	51.9 - j 21.9	1.54
28.4	11.17	26.41	47.1 + j 0.6	1.06
28.6	11.27	31.30	62.3 + j 16.0	1.43
28.8	10.33	12.67	34.0 + j 1.7	1.47
Average gain over 4-5: 0.42 dB			Average gain over 3-4: 1.25 dB	

Table 6. 10-Meter performance of 3 quad arrays.

The front-to-back curves in **Fig. 13** show something about where to place the peak front-to-back value for optimal performance--if there is design room to vary it without adversely affecting other properties. The 3-4-element array centers the curve. The 4-5-element version moves the maximum 180° front-to-back ratio to the upper end of the band. The result is lesser performance at the lower end of the band. However, the 180° front-to-back ratio is not the sole determiner of placement. The general shape of the rearward lobes and the strength of rearward side lobes can also play a role in the design decision. Placing the maximum front-to-back ratio at the high end of the band in the 4-5 array provided the best overall front-to-rear performance across the band.

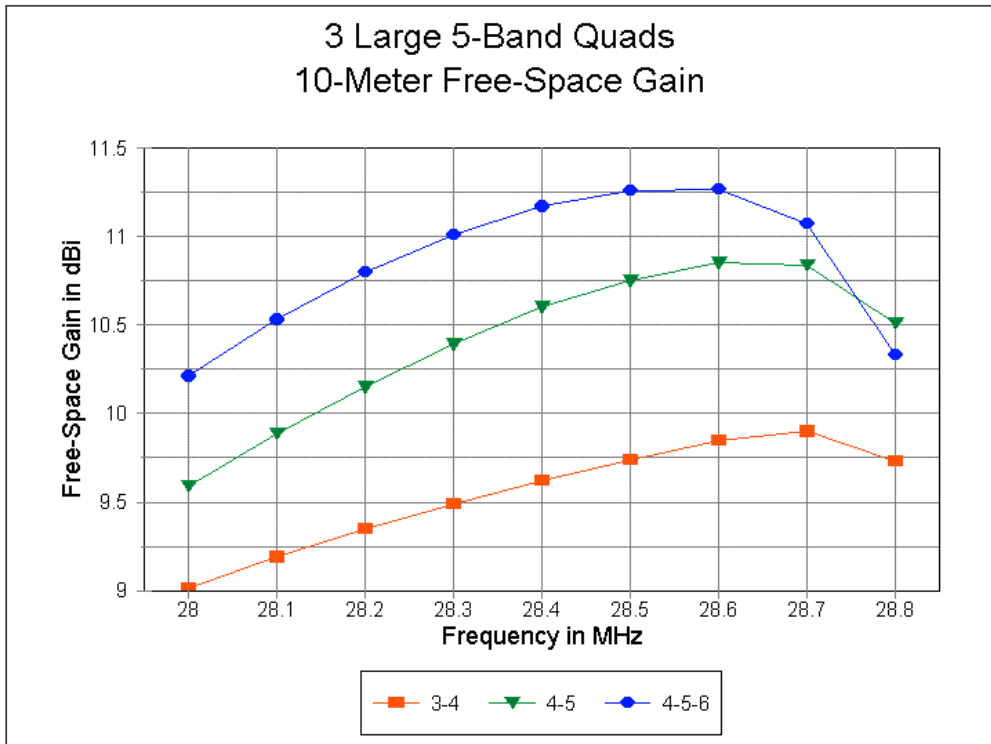

Fig. 12. 10-meter free-space gain for 3 large 5-band quad designs.

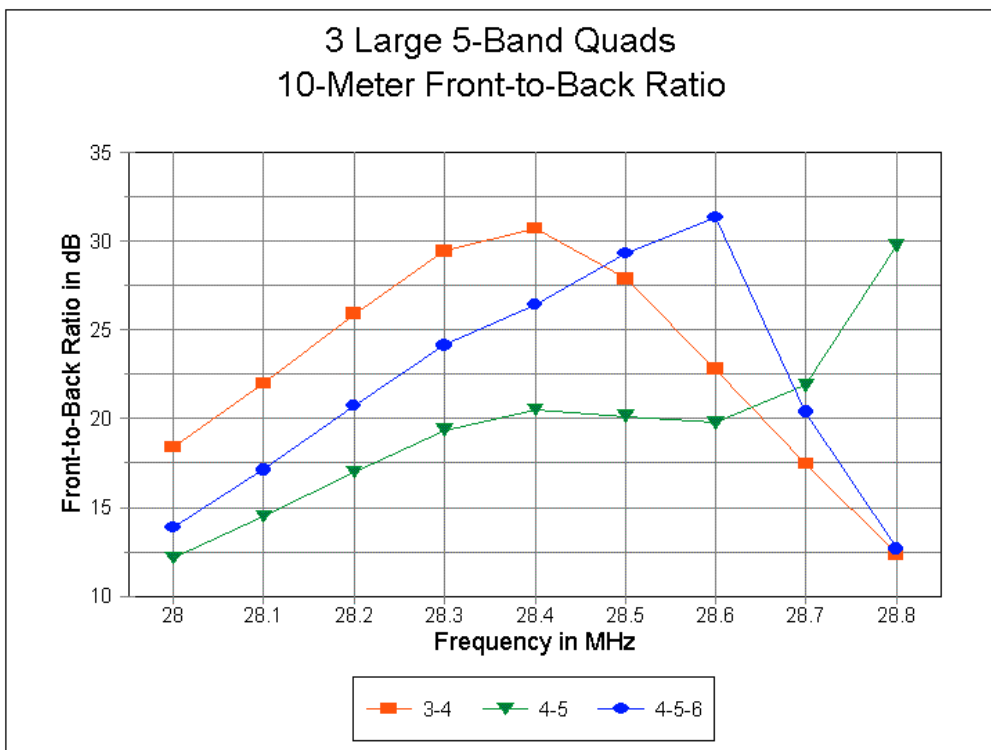

Fig. 13. 10-meter front-to-back ratios for 3 large 5-band quad designs.

The additional director to make the 10-meter section a 6-element array was prompted by the front-to-back performance as much as by the gain curve of the array without the added

director. **Table 6** shows the high in-band peak front-to-back ratio without the new director. The consequence is a relatively poor front-to-back performance except for a small portion of the band. With the added director, the front-to-back performance curve spreads the higher levels of performance over a greater portion of the band, although the band edges fall below the target levels given on the specifications.

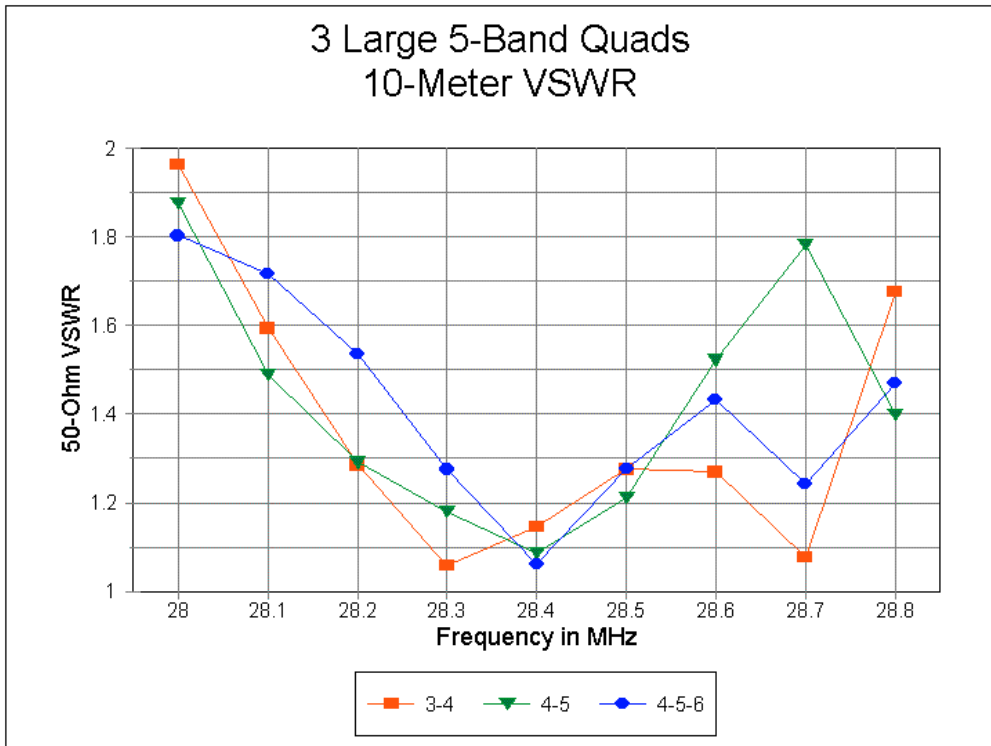

Fig. 14. 10-meter 50-Ω SWR curves for 3 large 5-band quad designs.

The added 10-meter director also resolves another problem. Without the director, the elevated level of SWR between the two wide-band minimums rises too high and exceeds the 2:1 level by a considerable amount at 28.6 MHz. As shown in **Fig. 14**, all three of the final versions of the arrays achieve the double-minimum wide-band curve, although in different patterns. The 4-5-6-element 30' array achieves the flattest curve of all, but all three curves remain below the 2:1 SWR level for the entire operating bandwidth. In both the 4-5 and 4-5-6 arrays, the first director plays its most significant role in setting the feedpoint impedance of the array and hence turns out to be smaller than the second director.

Overall Evaluation: The 4-5-element and the 4-5-6-element 5-band quads achieve most of the operating goals set forth in the original specifications for array gain. Each array exhibits increased gain as we change bands upward in frequency. Only 12 meters fails to provide at least 0.2 dB gain more for the 4-5-6 array over the 4-5 version. Only 20 meters fails to meet the goal of the 4-5 quad in providing at least 0.7 dB more gain than the array used as the starting point.

The front-to-back ratio goals--with cautions that we shall further discuss--are generally met except for the upper end of 20 meters and the passband edges of 10 meters. Both the 4-5-element and the 4-5-6-element quads cover all of the assigned passbands with under a 2:1 SWR relative to a 50-Ω standard. However, in several cases, the limit is pressed on one or the other end of the band, and on 20 meters, on both ends of the band.

Within these restrictions, then, the overall design is reasonably successful in achieving a design for a larger 5-band quad array. Indeed, more important than this overall evaluation are the design principles and limitations discovered along the design road. The notes on these matters give us some further insight into how multi-element, multi-band quads operate. Moreover, it is critical to understand that the designs emerged from some initial constraints of wire size and fixed element spacing. Revising the element spacing among sets of elements might yield differences of front-to-back ratio curves and SWR curves. Consequently, the designs are now suited to the application of both incremental and genetic optimizing routines. The incremental routines may provide further tweaking of the element sizes in the direction of perfected performance curves. Genetic algorithms might well uncover unsuspected potentials for the array designs.

Even if we accept the declaration of relative success in designing 4-5-element and 4-5-6-element quad arrays, the design process is far from over. First, there are some further general cautions about multi-band quads that deserve to be addressed. Second, although the use of antenna modeling software shows good efficiency in developing a design, if the design cannot be translated into an effective physical antenna with adequate performance, the exercise is idle. The interface of models and quad construction is an important aspect of the modeling-design process itself.

Limitations, Cautions, and Correlation Techniques

The numbers that emerge from an antenna-modeling program used to design a large quad array can be deceptive unless we use extreme caution in reading them and in using them to construct a physical version of the array. In this final part of the exercise, I want to explore at least some of the limitations and cautions that attach to the design model and to its transferal into wire and fiberglass.

Patterns: The basic design work has been done with free-space models. Hence, all gain figures require readjustment relative to a proposed height for the array above a specific ground quality. Ordinarily, the front-to-back ratio or rearward lobes and the SWR curve will hold good if the array is more than $1/4 \lambda$ above ground. Quads are less sensitive to ground influences on the feedpoint impedance and other operating characteristics than are arrays with open-ended linear elements. Of course, the exact gain of the strongest lobe and the elevation angle of that lobe will be functions of antenna height as measured in wavelengths or a fraction of a wavelength above ground.

With the exception of quite low mounting heights, azimuth patterns taken above ground will closely resemble at the elevation angle of maximum radiation the free-space patterns that we can take directly from the design model. However, we must adjust our expectations for such patterns to reflect a recognition of the high levels of interaction among the concentric elements of the array. Not all bands produce patterns that we have come to expect from monoband Yagis.

Fig. 15, for example, might represent both the 20-meter and 17-meter bands for the 4-5-6-element array. In both cases, we have well-behaved patterns, with single forward lobes and no forward side lobes. As well, we have radiation to the rear that follows fairly standard progressions of showing either 3 small rearward lobes or a single broad lobe or something in between the two. However, even the pattern for 18.168 MHz reveals a good reason for the quad array designer to look at each pattern within the list of check frequencies. The rearward pattern at the upper end of 17 meters shows a worst-case front-to-back ratio of about 17.5 dB, despite a 180° front-to-back

ratio of better than 20 dB.

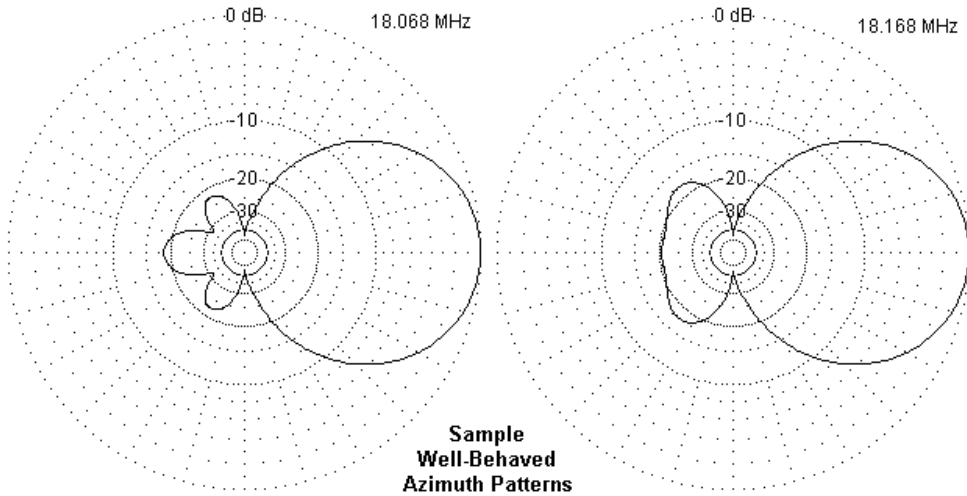

Fig. 15. Samples of well-behaved free-space azimuth patterns from 17 meters.

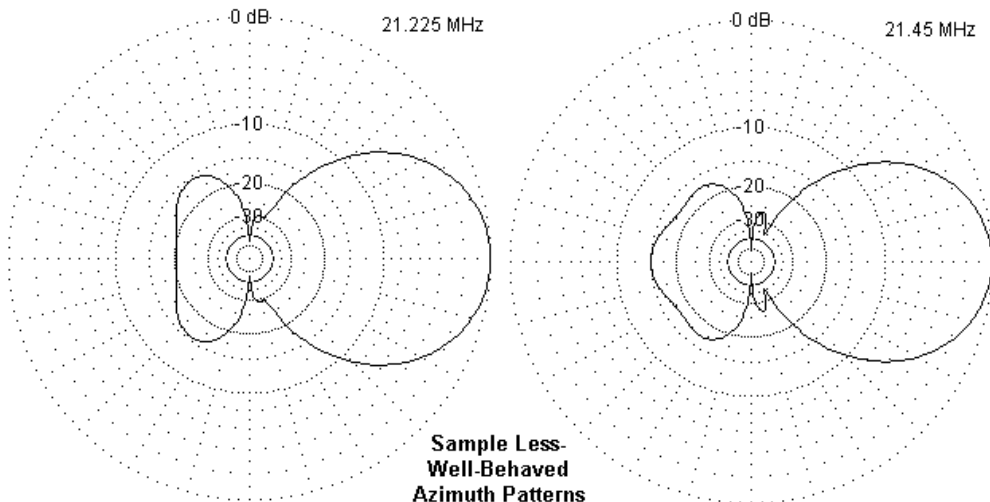

Fig. 17. Samples of less well-behaved free-space azimuth patterns from 15 meters.

Above 17 meters, the patterns--both forward and rearward--can grow considerably less well behaved. In the progression from the middle of 15 meters to the upper end (**Fig. 16**), we find the development of forward side lobes. Although they remain diminutive at 15 meters, on higher bands, the side lobes can grow to proportions that affect the overall forward beamwidth of the array between -3 dB power points. In addition, the merely large rear radiation patterns, with a worst-case ratio to the forward lobe of 15 dB, evolves into a very broad pattern. The broader pattern may have operational consequences, since response to the rear would no longer be to a pair of narrow directions, but instead would cover most of the rear quadrants. Needless to say, pre-construction evaluation of a large quad array design must include an evaluation of whether or not the patterns (as well as the performance numbers) are satisfactory for the intended operation.

Efficiency: The NEC core that is the heart of most common antenna modeling software

provides a power budget that lists a value for efficiency. The efficiency of an antenna is simply the power radiated (without regard to where it goes) to the power supplied to the antenna--and then converted to a percentage. The calculation does not include anything not modeled, for example, matching sections or networks, feedline losses, etc. However, it does include material losses within the antenna elements as a result of their resistivity, and it also included resistive losses associated with any traps or reactive loads. This latter category of losses does not apply to the quad arrays, but wire losses do apply, since we are using #12 AWG copper wire. The wire size is as important as the material, since skin effect is partially a function of element surface area. In fact, with high levels of surface area, such as with the use of aluminum tubing, material losses can be minimal. For example, there are models of 6-element Yagis in my collection with efficiencies approaching 99%.

The thinner the wire as a fraction of a wavelength and the higher the frequency, the greater the losses and the lower the efficiency of an antenna. These general rules would reveal themselves if we developed a sequence of simple monoband Yagis by which to test them. However, the large quads that we have been exploring display complex interactions among the elements. In doing so, they reveal another dimension to antenna efficiency that is not as well appreciated as element diameter and frequency.

Radiation Efficiencies of 3 Large Quad Arrays

Band Meters MHz	Frequency	Antenna Efficiency (%)		
		3-4-Element	4-5-Element	4-5-6-Element
20	14.175	93.6	94.6	94.4
17	18.118	93.9	92.7	93.3
15	21.225	94.1	92.7	93.7
12	24.94	90.1	87.7	80.4
10	24.4	93.6	91.9	90.7

Note: Efficiency is the ratio of power radiated to the power supplied to the antenna and does not include matching or line losses.

Table 7. Radiation efficiencies of 3 large quad arrays.

Table 7 lists the calculated mid-band efficiencies of each of the quads we have reviewed. Note that the highest efficiency is considerably lower than that for a "fat-element" Yagi. Although we can detect a drift in the general direction claimed by the rules, the set of numbers does not clearly correspond with expectations bred by the rules. Especially noticeable is the very low figure for 12 meters on the largest array.

If we return to **Table 5**, we would discover that the 12 meter portion of the largest array provided less than 0.1 dB gain advantage over the next shorter quad, with most other characteristics being roughly equal between the two. What limits the gain is the inability of the elements on their fixed spacings to achieve the most effective inter-element coupling to yield a higher gain. If the larger array had resulted in significantly larger rear lobes, the efficiency might have been higher. Had it resulted in higher forward gain--or even a wide beamwidth--we might also see a higher efficiency value. However, we often neglect a third possibility: the current distribution in all elements is such that the sum of radiation in all directions does not increase, but instead, the current levels are higher in regions of the antenna where losses exceed contributions

to radiation. The result is lower efficiency without a change in wire size, wire lengths, or frequency. For the 12-meter case, one might raise efficiency somewhat by adding the fourth director (as was done on 10 meters), even though it would add to wire losses. As well, one might optimize further the relative spacing of the 12- and 10-meter drivers from the reflector.

Efficiency is (or can be) an indicator of possible design improvement. However, it does not affect the reported gain of the array, since that gain already takes into account the radiation efficiency of the total antenna model. Indeed, attaching the wrong significance to efficiency can result in a misuse of the data. For example, achieving 99% efficiency in a directional array, where the added radiation is to the rear or sides, would not amount to a design improvement.

Element Precision: An array with highly interactive parasitic elements requires considerable precision in construction to achieve the design results. One aspect of construction precision is understanding which elements can be adjusted and which should be precisely built and then left alone. The following guidelines may be useful, although their application may vary from one design to another.

1. Reflector-driver-first director: For arrays with 2 or more directors on a band, fine-tuning the reflector-driver-first director combination tends to function predominantly in setting the source impedance across the band in question. Once set, it is useful not to perform further adjustments on this set of elements--with one exception. The driver can be adjusted to shift the reactance levels. However, reductions in driver size will normally also reduce the resistive component of the feedpoint impedance, and increases in size will raise the feedpoint's resistive component. In constructing a given large array design, adjustments here should be near to last.

2. First director: Where there are 2 or more directors, the size of the first director may be sufficiently critical that, once set, it should not be altered. On some bands, under a 1" change in the first director can create large changes in the performance within a given passband, and these large changes may involve any of the key operating parameters: gain, front-to-back ratio, or SWR curve. In general, the further forward the changes, the less critical they are for a given amount of change.

3. The two forward-most directors: As **Table 1** may reveal by comparing dimensions among arrays, one can go far toward controlling the characteristics of any band served by a large array by changing the forward directors. For wide-band service, the most forward director becomes shorter to enhance high-end performance and the next director to the rear become larger to enhance low-end performance. Both moves tend to raise the feedpoint resistive component a bit, which is why hasty adjustments to the driven element should be avoided.

Obviously, where there are too few elements to adhere to these guidelines, other measures are required. For example, a band with 4 elements may require a slight enlargement of the reflector to enhance low-end performance. However, this move may require re-adjustment of the driver and first director to restore or obtain a desired feedpoint impedance and SWR curve across the band. A 3-element band becomes a ballet of interactions among the elements such that the reflector is normally used to control both radiation resistance and low-end performance, while the director controls high-end performance, with the driver sized to create the best possible situation for the antenna feed. Since large multi-band quad arrays normally begin with fixed spacing, there are many instances where meeting design specifications may not be possible.

Correlations between models and reality. Because many dimensions within a large multi-band quad array require precise measurement of the loop circumference to within less than 1", constructing such an array is not a casual endeavor. Indeed, it may lie beyond the realm of simple backyard build-and-play techniques. However, with some care, trials, and testing, constructing a modeled design is perfectly feasible. The key lies in understanding both the model and the realities of a proposed construction technique. The two can be correlated.

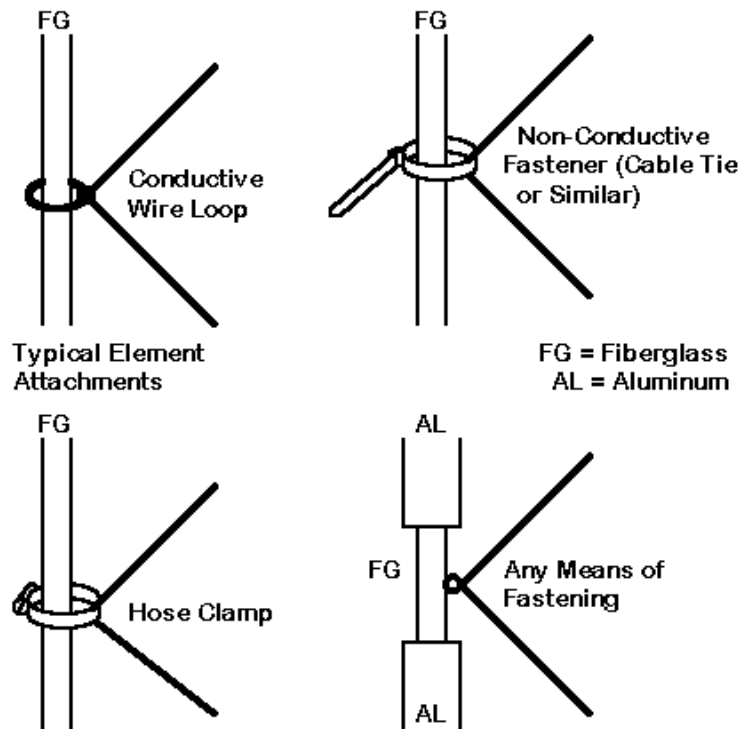

Fig. 17. Sample element-to-support mounting techniques.

Fig. 17 sketches loosely some of the ways in which many builders attached quad loop corners to the support arms. In two of the versions, we have metal rings wrapped around the non-conductive support arm. In many cases, the wire will be wrapped at the corner to reduce abrasion. Whether or not directly connected, we have a small closed 1-turn coil in close proximity to the quad loop corner. The current at a quad loop corner is significant, in fact, higher than the current magnitude on a linear element the same distance from center. The closed loop may function as a load on the quad loop, and it does not take much of a load to detune the element relative to the original model of the loop. Similarly, when quad arms are composed of combinations of aluminum and non-conductive material, the aluminum may be close enough to the loop corner to create a slight detuning, equivalent to adding a very small load to the wire loop.

Of the 4 variations on wire attachment to a support arm, the cable-tie system comes closest to matching the computer model, although an anti-abrasion sleeve may constitute a small distance over which the wire can be considered insulated. Insulated wire creates a velocity factor for the wire, making the physical and electrical length of the wire unequal. Corner sleeves may turn out to be harmless relative to the complex operation of a large multi-band array, but they should never be presumed to be harmless.

There is a tedious but straightforward way to determine to what degree construction practices may affect the operation of a quad relative to the "clean," bare wire model on which it may be based. First, model only the driven element assembly or assemblies. Determine as precisely as feasible the resonant frequency of each driver. Second, build as precisely as possible the driver assemblies in accord with the proposed method of construction and elevate them to a good height. Determine the resonant frequency of each driver. Either the resonant frequencies match those of the model or, a pattern of offset will become evident. The absence of a pattern will likely be good reason for reviewing the initial driver construction.

Relative to the measured resonant frequencies, add loads of the appropriate reactive amounts to each of the 4 corners of each driver so that the model resonates at the same frequency as the driver assembly tested. For each band, adding the same loads to each of the four corners of quad loops on that band will be a quite accurate approximation of the construction technique effects on the entire set of elements. Now readjust the dimensions of the model to restore the performance curves of the original model. The resulting dimensions should result in correct operation of the array on all frequencies.

I can only state that they "should result in correct operation," but the effectiveness of the technique will rest upon the precision with which the array is constructed during both the test and "final" construction phases of the operation. Large quad arrays such as the ones discussed in these notes require dimensional precision to within an inch on some elements. Even small amounts of loading or detuning on some elements may throw the array off the desired performance curve on some bands.

Variations of the technique suggested here for correlating modeled quads and physical quads are adaptable to many other types of antennas. More important is the general thesis that models--usually using bare wire and with no modeled detuning effects--require correlation to the physical construction methods employed by the builder if the models are to be adequate guides to antenna design. Any success in building a large multi-element, multi-band quad of the order discussed in these notes will depend upon this step as much as any other in the design process.

The design of a large multi-band quad array intended for eventual construction can be enhanced by the proper use of antenna modeling software. However, as we have seen, the task is not an idle modeling exercise. It must be preceded by careful consideration of constraints, specifications, and modeling strategies to ensure reasonable results. Moreover, the task is not completed unless the final design model is carefully evaluated and then correlated to the proposed construction methods. These notes have had as their goal to make the process orderly, but by no means brief.

Notes

1. *Quad Notes*, Vol. 2 (Corpus Christi: AntenneX, 2001), throughout.
2. *Quad Notes*, Vol. 1 (Corpus Christi: AntenneX, 2000), Chapter 5.
3. *Quad Notes*, Vol. 1 (Corpus Christi: AntenneX, 2000), pp. 206-216. See also Danny Mees, ON7NQ, "Improving the Cubex Three-Element, Five-Band Quad," *Antenna Compendium*, Vol. 6, pp. 119-20.
4. For a description of the set of "optimized wide-band antennas" or OWA Yagis, explore the following web site: <http://www.contesting.com/nw3z/>.

Copyright ARRL (2003), all rights reserved. This material originally appeared in *QEX: Forum for Communications Experimenters*, Nov, 2003, pp. 12-24 (www.arrl.org/qex). Reproduced with permission.